



■ Vers. 450+338+452



■ Vers. 072+489+338+452



■ Vers. 450+452



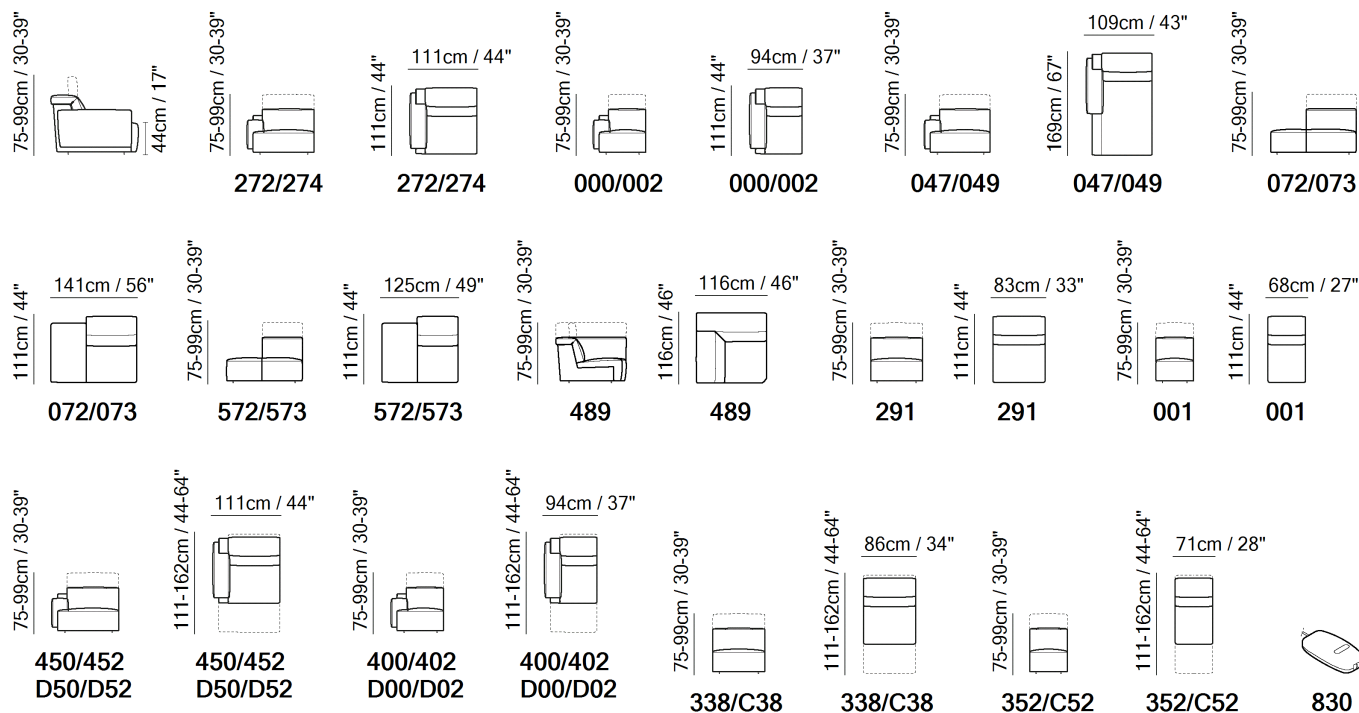

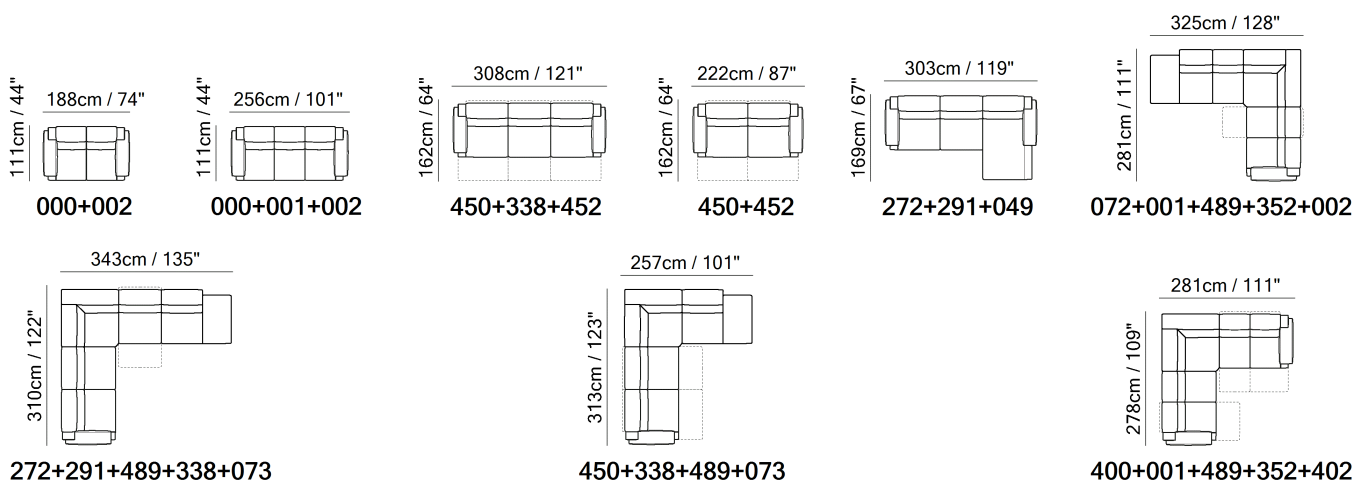

SCHEMATICS



COMPOSITION EXAMPLES



TECHNICAL INFORMATION

| | | | | | | |
|----------------------------------------------------------------------------------|-----------------|----------------------------------------------------------------------------------------------------------------------------------------------------------------------|------------------------------------------------------------------------------------------------------------------------------------------------------------------------------|------------------------------------------------------------------------------------------------------------------------------------------------------------------------------|--------------------------------------|-----------------------------------------|
|  | COVERING | Leather <input checked="" type="checkbox"/> | Soft Cover <input checked="" type="checkbox"/> | | | |
|  | LEGS | Wood <input type="checkbox"/> | Metal <input type="checkbox"/> | Plastic <input checked="" type="checkbox"/> | Castors <input type="checkbox"/> | Upholstered <input type="checkbox"/> |
|  | FILLING | Arms <input type="checkbox"/> Fiber <input checked="" type="checkbox"/> Foam <input type="checkbox"/> Feather/Fiber Mix <input type="checkbox"/> Feather | Seat cushion <input type="checkbox"/> Fiber <input checked="" type="checkbox"/> Foam <input type="checkbox"/> Feather/Fiber Mix <input type="checkbox"/> Feather | Back cushion <input type="checkbox"/> Fiber <input checked="" type="checkbox"/> Foam <input type="checkbox"/> Feather/Fiber Mix <input type="checkbox"/> Feather | | |
|  | COMFORT | Standard Comfort <input checked="" type="checkbox"/> | Firm Comfort <input type="checkbox"/> | | | |
|  | FUNCTION | Bed <input type="checkbox"/> | Electric motion <input checked="" type="checkbox"/> | Motion <input checked="" type="checkbox"/> | Recliner <input type="checkbox"/> | Sliding <input type="checkbox"/> |
|  | OPTIONS | Contrast Stitching <input type="checkbox"/> | Removable <input type="checkbox"/> | Nails <input type="checkbox"/> | | |

NOTES

- Designed by Marek Bujanowski.
- Date of launch: 2015.
- The square and linear shapes of Iago combine in perfect harmony with the softness of the padding and give it a pleasantly surprising appearance. The particularly low seating offers comfort and aesthetic appeal. Beauty meets innovation in this sofa: in fact the recline system ensures maximum comfort with the adjustable footrest and headrest, adaptable to your individual needs.
- Seat cushion includes a layer of memory foam, a pressure-sensitive soft polyurethane, that recovers its form completely thus giving great comfort.
- Available with Soft Touch mechanism that changes the seat and back cushion position with a simple tap.
- Model has power combined headrest. ATTENTION! The headrest opens first followed by the footrest; then the headrest has one final extra rotation for comfortable TV watching position.
- Thanks to ZeroWall mechanism, seat and back cushions can be reclined at a great length without moving sofa away from the wall.
- Stationary versions have manually adjustable headrests.
- Second option version corner 489 has both headrests adjustable.
- Versions Cxx-Dxx are available with rechargeable battery pack. There is a power cord outlet with a finish grommet on the lower back of the sofa rather than the bottom. This design allows for easy plug and unplug action for charging.
- Seat and back cushions are fixed to the frame.
- No Leather Side (the sectional pieces have the side covered with lining and not leather)

NOTES

- Internal wooden frame.
- Feet requires assembling. Feet will be in a bag inside the package.
- Feet height 5,0 cm